

JVC



CD/CASSETTE RECEIVER

KW-XC770

ENGLISH

RECEPTOR DE CD-CASSETTE

KW-XC770

ESPAÑOL

RADIOCASSETTE/CD

KW-XC770

FRANÇAIS

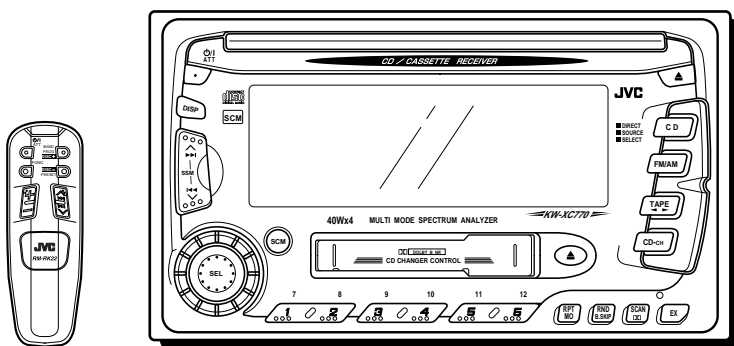

**COMPACT
disc**
DIGITAL AUDIO

For installation and connections, refer to the separate manual.
Para la instalación y las conexiones, refiérase al manual separado.
Pour l'installation et les raccordements, se référer au manuel séparé.

INSTRUCTIONS

MANUAL DE INSTRUCCIONES
MANUEL D'INSTRUCTIONS

For customer Use:

Enter below the Model No. and Serial No. which are located on the top or bottom of the cabinet. Retain this information for future reference.

Model No. _____

Serial No. _____

LVT0400-001A
[J]

INFORMATION (For USA)

This equipment has been tested and found to comply with the limits for a Class B digital device, pursuant to Part 15 of the FCC Rules. These limits are designed to provide reasonable protection against harmful interference in a residential installation. This equipment generates, uses, and can radiate radio frequency energy and, if not installed and used in accordance with the instructions, may cause harmful interference to radio communications. However, there is no guarantee that interference will not occur in a particular installation. If this equipment does cause harmful interference to radio or television reception, which can be determined by turning the equipment off and on, the user is encouraged to try to correct the interference by one or more of the following measures:

- Reorient or relocate the receiving antenna.
- Increase the separation between the equipment and receiver.
- Connect the equipment into an outlet on a circuit different from that to which the receiver is connected.
- Consult the dealer or an experienced radio/TV technician for help.

IMPORTANT FOR LASER PRODUCTS**Precautions:**

1. CLASS 1 LASER PRODUCT
2. **DANGER:** Invisible laser radiation when open and interlock failed or defeated. Avoid direct exposure to beam.
3. **CAUTION:** Do not open the top cover. There are no user-serviceable parts inside. Leave all servicing to qualified service personnel.
4. **CAUTION:** This CD player uses invisible laser radiation, however, is equipped with safety switches to prevent radiation emission when unloading CDs. It is dangerous to defeat the safety switches.
5. **CAUTION:** Use of controls, adjustments or performance of procedures other than those specified herein may result in hazardous radiation exposure.

CAUTION on Volume Setting

CDs produce very little noise compared with other sources. If the volume level is adjusted for the tuner, for example, the speakers may be damaged by the sudden increase in the output level. Therefore, lower the volume before playing a CD and adjust it as required during playback.

To reset your unit

After installing the unit or when you have troubles with operations, reset the microcomputer built in this unit.

Press the reset button on the front panel using a ball-point pen or a similar tool.

- **REMEMBER** your preset adjustments such as preset channels or sound adjustments will also be erased from memory.

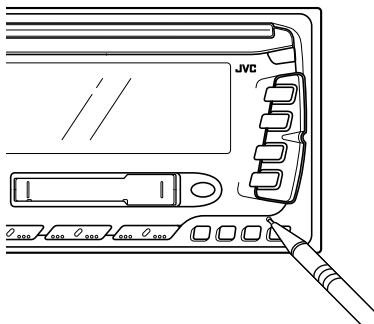

Thank you for purchasing a JVC product. Please read all instructions carefully before operation, to ensure your complete understanding and to obtain the best possible performance from the unit.

CONTENTS

BASIC OPERATIONS 5



RADIO OPERATIONS 6

Listening to the radio 6
 Storing stations in memory 7
 Automatic preset: SSM 7
 Manual preset 8
 Storing your favorite station into the EX (extra) button 9
 Tuning into a preset station 10
 Other convenient tuner functions 11
 Scanning broadcast stations 11
 Selecting FM reception sound 11
 Changing the AM/FM channel intervals 11

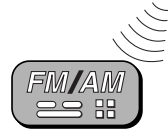

CD OPERATIONS 12

Playing a CD 12
 Locating a track or a particular portion on a CD 13
 Fast-forwarding or reversing the track 13
 Going to the next track or the previous track 13
 Going to a particular track directly 13
 Other convenient CD functions 14
 Selecting CD playback modes 14
 Prohibiting CD ejection 14



TAPE OPERATIONS 15

Listening to a tape 15
 Finding the beginning of a tune 17
 Other convenient tape functions 18
 Skipping blank portions on the tape 18
 Playing the current tune repeatedly 18
 Prohibiting tape ejection 18



SOUND ADJUSTMENTS 19

Selecting preset sound modes 19
 Adjusting the sound 20
 Storing your own sound adjustments 21



SPECTRUM ANALYZER 22

Selecting spectrum analyzer patterns 22
 Spectrum analyzer patterns 23



CONTINUED TO THE NEXT PAGE

OTHER MAIN FUNCTIONS 24

Changing general settings (PSM) 24

 Setting the clock 24

 Turning on or off the key-touch tone 25

 Selecting the dimmer mode 25

 Selecting the external component to use 26

 Turning on or off the display demonstration 26

REMOTE OPERATIONS 27

Installing the batteries 27

Using the remote controller 28

CD CHANGER OPERATIONS 29

Playing CDs 29

Selecting CD playback modes 31

EXTERNAL COMPONENT OPERATIONS 32

MAINTENANCE 33

Handling cassettes 33

Handling CDs 34

TROUBLESHOOTING 35

SPECIFICATIONS 37

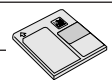

BEFORE USE

*** For safety....**

- Do not raise the volume level too much, as this will block outside sounds, making driving dangerous.
- Stop the car before performing any complicated operations.

*** Temperature inside the car....**

If you have parked the car for a long time in hot or cold weather, wait until the temperature in the car becomes normal before operating the unit.

BASIC OPERATIONS

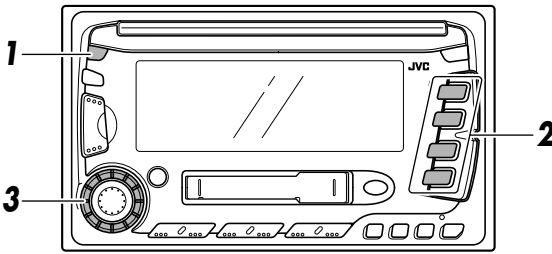

Note:

When you use this unit for the first time, set the built-in clock correctly, see page 24.

1



Turn on the power.

“HELLO” appears on the display.

Note on One-Touch Operation:

When you select a source in step 2 below, the power automatically comes on. You do not have to press this button to turn on the power.

2

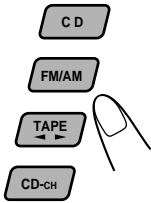

Select the source.

To operate the tuner, see pages 6 – 11.

To operate the CD player, see pages 12 – 14.

To operate the tape deck, see pages 15 – 18.

To operate the CD changer, see pages 29 – 31.

To operate an external device, see page 32.

3

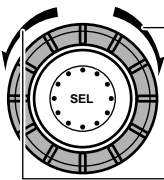

To turn up the volume

To turn down the volume

Adjust the volume.

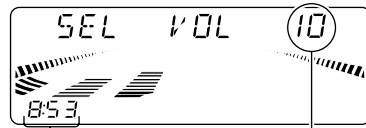

Clock time

Volume level

4

Adjust the sound as you want (see pages 19 – 21).

- If you need to change the spectrum analyzer pattern, see page 22.

To drop the volume in a moment

Press **ATT** briefly while listening to any source. “ATT” starts flashing on the display, and the volume level will drop in a moment.

To resume the previous volume level, press the button briefly again.

To turn off the power

Press **ATT** for more than 1 second. “SEE YOU” appears, then the unit turns off.

- If you turn off the ignition key without turning off this unit, the unit will automatically turn on when you turn on the ignition key next time. If the last selected source is ready for playback (ex. a CD or a tape is in the unit), playback starts automatically.



RADIO OPERATIONS

ENGLISH

Listening to the radio

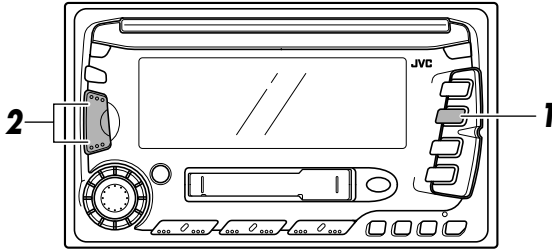

1



Select the band (FM1, FM2, FM3 or AM).

You can select any one of FM1, FM2, and FM3 to listen to an FM station.

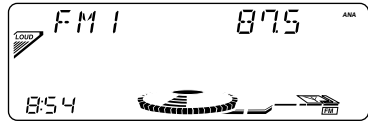
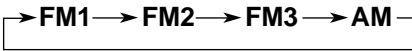

2

Start searching a station.

When a station is received, searching stops.

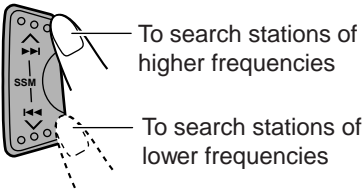

To stop searching before a station is received, press the same button you have pressed for searching.

To tune in a particular frequency manually:

1 Press FM/AM repeatedly to select the band (FM or AM).

2 Press and hold **▶▶|▲** or **◀◀|▼** until "MANU" flashes on the display.

Now you can manually change the frequency while "MANU" is flashing.

3 Press **▶▶|▲** or **◀◀|▼** repeatedly until the frequency you want is reached.

- If you hold down the button, the frequency keeps changing until you release the button.

Storing stations in memory

You can use one of the following methods to store broadcasting stations in memory.

- Automatic preset: SSM (Strong-station Sequential Memory)
- Manual preset
- Storing your favorite station into the EX button

Automatic preset: SSM

You can preset 6 local stations in each FM band (FM1, FM2, and FM3) and 6 local stations in AM band.

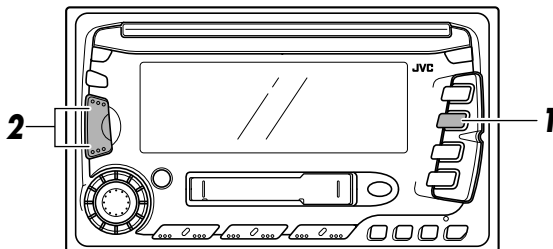
1

Select the band (FM1, FM2, FM3 or AM).

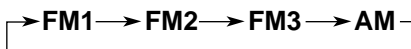
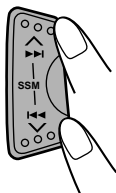
2

Press and hold both buttons for more than 2 seconds.

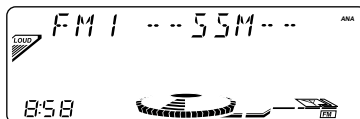

“SSM” appears, then disappears when automatic preset is over.

Local stations with the strongest signals are searched and stored automatically in the band you have selected (FM1, FM2, FM3, or AM). These stations are preset in the number buttons — No. 1 (lowest frequency) to No. 6 (highest frequency).

When automatic preset is over, the station stored in number button 1 will be automatically tuned in.



Manual preset

You can preset up to 6 stations in each band (FM1, FM2, FM3 and AM) manually.

EXAMPLE: Storing an FM station of 88.3 MHz into the preset channel number 1 of the FM1 band

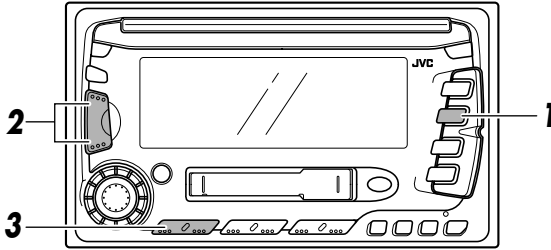

1



Select the FM1 band.

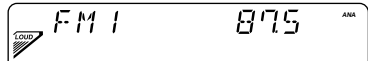

2

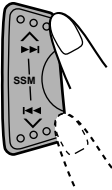

Tune into a station of 88.3 MHz.
See page 6 to tune into a station.

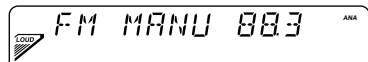

3

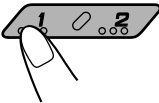

Press and hold the button (in this example, number 1 button) until channel number flashes (in this example "1ch").

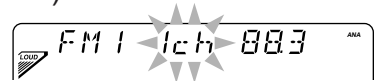
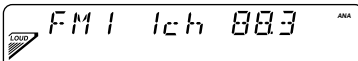

"1ch" flashes for a few seconds, showing that the station has been preset.

4

Repeat the above procedure to store other stations into other preset channel numbers.

Notes:

- A previously preset station is erased when a new station is stored in the same preset channel number.
- Preset stations are erased when the power supply to the memory circuit is interrupted (for example, during battery replacement). If this occurs, preset the stations again.

Storing your favorite station into the EX (extra) button

You can preset an FM or AM station (such as your favorite station or traffic announcement station); and recall it by one touch operation even if the unit is turned off.

EXAMPLE: Storing an FM station of 88.3 MHz into the EX button

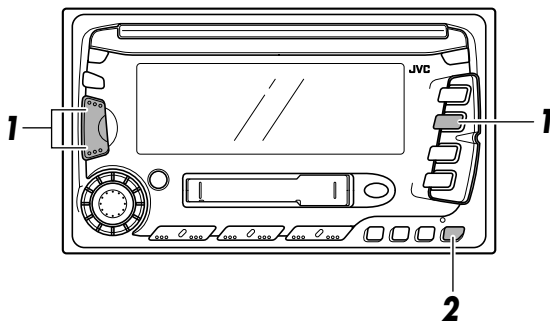
1

Follow the steps **1** and **2** on page 6.

2

Press and hold the button until “FM” flashes.

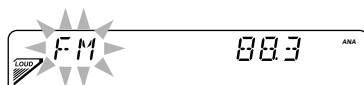

“FM” flashes on the display, showing that the station has been preset.

Notes:

- A previously preset station is erased when a new station is stored.
- Preset station is erased when the power supply to the memory circuit is interrupted (for example, during battery replacement). If this occurs, preset the station again.



Tuning into a preset station

You can easily tune into a preset station.

Remember that you must store stations first. If you have not stored them yet, see pages 7 to 9.

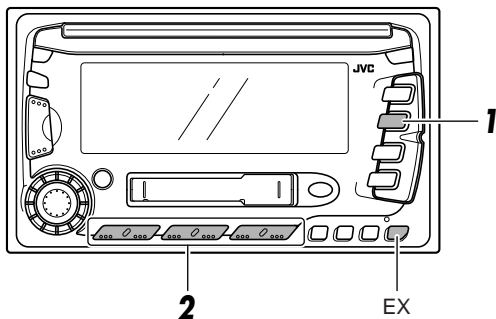

1



Select the band (FM1, FM2, FM3 or AM) you want.

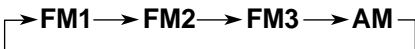

2

Select the number (1 – 6) for the preset station you want.

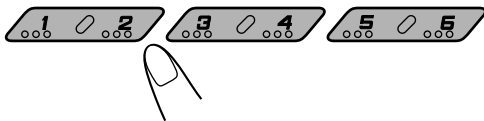

To tune in the favorite station (EX)



The unit automatically turns on (if it has been off). Your favorite station is tuned in, and the volume level is automatically set to the one when this function has been used before.

- If you press the button again, the previous source will be played back again at the previous volume level.

Note:

If you adjust the volume while this function is in use, it is automatically stored for this function.

Other convenient tuner functions

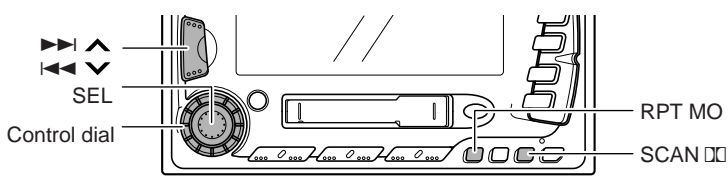

Scanning broadcast stations



When you press SCAN (Scan/Dolby NR) while listening to the radio, station scanning starts. ("SCAN" appears on the display.) Each time a broadcast is tuned in, scanning stops for about 5 seconds (tuned frequency number flashes on the display), and you can check what program is now being broadcasted.

If you want to listen to that program, press the same button again to stop scanning.

Selecting FM reception sound

When an FM stereo broadcast is hard to receive:

Press RPT MO (Repeat/Monaural) while listening to an FM stereo broadcast. The sound you hear becomes monaural but reception will be improved.

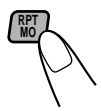

Lights up when receiving an FM broadcast in stereo.

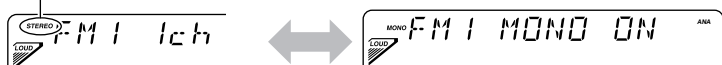

To restore the stereo effect, press the same button again.

Changing the AM/FM channel intervals

When this unit is shipped from the factory, the channel intervals are set to 10 kHz for AM and 200 kHz for FM (so that the unit can be used in North and South America).

When using this unit in an area other than North and South America, change the channel intervals by following the procedure below.

- AREA EU: Select this when used in an area other than North and South America.
- AREA US: Select this when used in North or South America.

- 1 Press SEL for more than 2 seconds.
One of the PSM items appears on the display.
- 2 If "PSM AREA" does not appear, press ►► ▲ or ◀◀ ▼ repeatedly until it appears.
- 3 Turn the control dial to the right.
"AREA EU" appears and the channel intervals are set to 9 kHz for AM and 50 kHz (for manual tuning) / 100 kHz (for searching) for FM.
- 4 Press SEL again to finish the setting.

To reset to the factory setting, follow the above step 1 and 2, then turn the control dial to the left in step 3 ("AREA US" appears on the display).



CD OPERATIONS

ENGLISH

Playing a CD

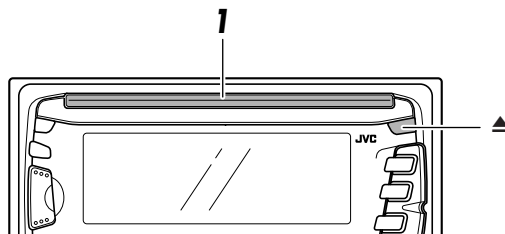

1

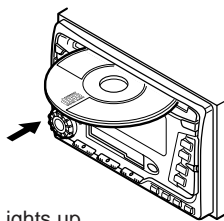

Insert a disc into the loading slot.

The unit turns on, draws a CD and starts playback automatically.

- Insert the CD with the printed face facing up.

Lights up



Total track number of the inserted disc Total playing time of the inserted disc

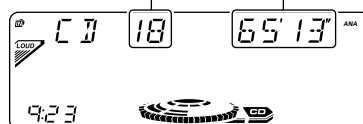

Current track Elapsed playing time

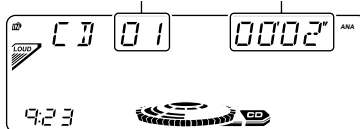

Note on One-Touch Operation:

When a CD is already in the loading slot, pressing CD turns on the unit and starts playback automatically.

To stop play and eject the CD

Press ▲.

CD play stops and the CD automatically ejects from the loading slot ("CD EJECT" appears on the display). The source changes to the last selected source.

If you change the source, the CD play also stops (without ejecting the CD this time).

- If the ejected disc is not removed for about 15 seconds, the disc is automatically inserted again into the loading slot to protect it from dust. (CD play will not start this time.)
- You can eject the CD even when the unit is turned off.



Locating a track or a particular portion on a CD

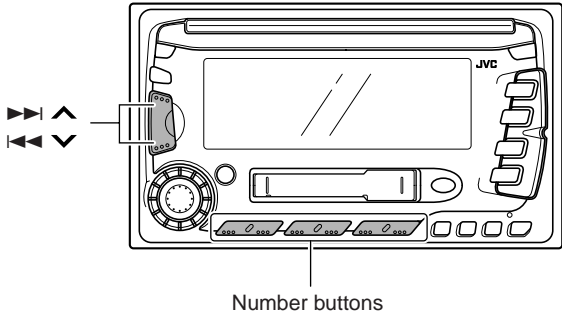

Fast-forwarding or reversing the track



Going to the next tracks or the previous tracks

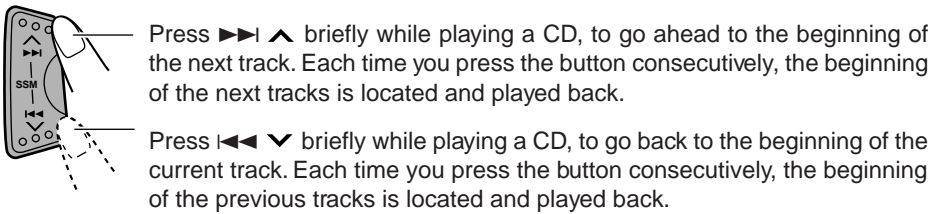

Going to a particular track directly

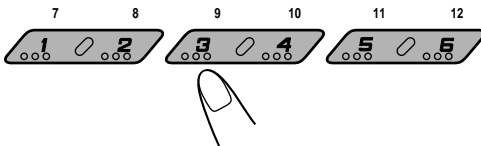

Press the number button corresponding to the track number to start its playback.

- To select a track number from 1 – 6:
Press 1 (7) – 6 (12) briefly.
- To select a track number from 7 – 12:
Press and hold 1 (7) – 6 (12) for more than 1 second.



Other convenient CD functions

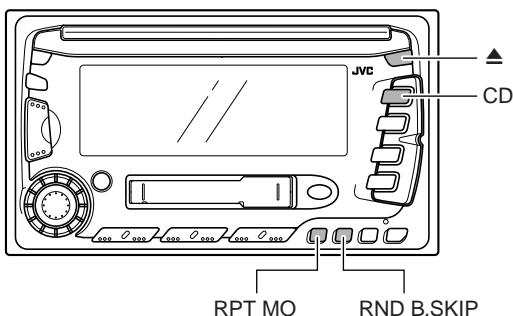

Selecting CD playback modes

■ To play back tracks at random (Random Play)

You can play back all tracks on the CD at random.



Each time you press RND B.SKIP (Random/Blank Skip) while playing a CD, CD random play mode turns on ("RANDOM ON") and off ("RANDOM OFF") alternatively.

When the random mode is turned on, the RND indicator lights up on the display and a track randomly selected starts playing.

■ To play back tracks repeatedly (Repeat Play)

You can play back the current track repeatedly.



Each time you press RPT MO (Repeat/Monaural) while playing a CD, CD repeat play mode turns on ("REPEAT ON") and off ("REPEAT OFF") alternatively.

When the repeat mode is turned on, the RPT indicator lights up on the display.

Prohibiting CD ejection

You can prohibit the CD ejection and can "lock" a CD in the loading slot.



Press and hold CD and ▲ for more than 2 seconds. "CD EJECT" appears, then "EJECT" flashes on the display for about 5 seconds, and the CD is "locked."

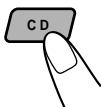

To cancel the prohibition and "unlock" the CD, press and hold CD and ▲ for more than 2 seconds again. "CD EJECT" appears, then "EJECT" flashes on the display for about 5 seconds, and the CD is "unlocked."

(at the same time)

TAPE OPERATIONS



ENGLISH

Listening to a tape

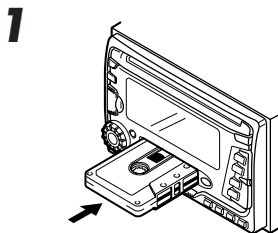
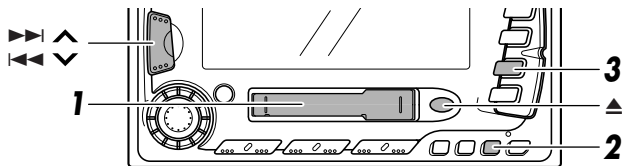

1 Insert a cassette.

The unit turns on and tape play starts automatically. When one side of the tape reaches its end during play, the other side of the tape automatically starts playing. (Auto Reverse)

Note on One-Touch Operation:
When a cassette is already in the cassette compartment, pressing TAPE ◀▶ turns on the unit and starts tape play automatically.

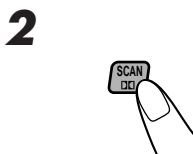

2 Turn on or off the Dolby B NR* as needed.

Each time you press the button, the Dolby B NR turns on ("DOLBY B ON") and off ("DOLBY B OFF").



This indicator lights up when the Dolby B NR is turned on.



3 Select the tape direction.

Each time you press the button, the tape direction changes alternatively.



* Dolby noise reduction manufactured under license from Dolby Laboratories Licensing Corporation. "Dolby" and the double-D symbol  are trademarks of Dolby Laboratories Licensing Corporation.



To stop play and eject the cassette

Press ▲.

Tape play stops and the cassette automatically ejects from the cassette compartment.

If you change the source, the tape play also stops (without ejecting the cassette this time).

- *You can also eject the cassette with the unit turned off.*

To fast-forward and rewind a tape

- Press ►► | ▲ for more than 1 second to fast-forward the tape.

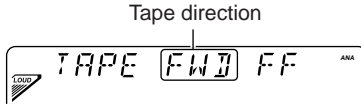

When the tape reaches its end, the tape is reversed and playback starts from the beginning of the other side.

- Press | ◀◀ ▼ for more than 1 second to rewind the tape.

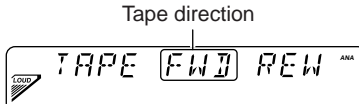

When the tape reaches its end, playback of the same side starts.

To stop fast-forward and rewind at any position on the tape, press TAPE ◀ ►.

Tape play starts from that position on the tape.



Finding the beginning of a tune

Multi Music Scan allows you to automatically start playback from the beginning of a specified tune. You can specify up to 9 tunes ahead or before the current tune.

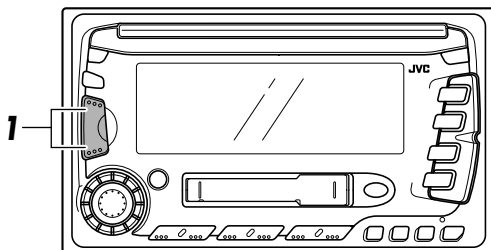

1 During playback

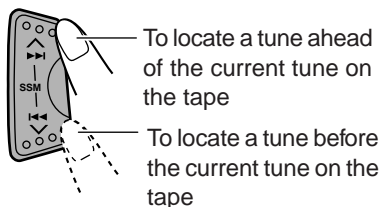

Specify where (how many tunes ahead of or before the current tune) the tune you want is located.



Each time you press the button, the number changes up to ± 9 .

When the beginning of the specified tune is located, playback starts automatically.

Notes:

- *While locating a specified tune:*
 - If the tape is rewound to its beginning, playback starts from the beginning of that side.
 - If the tape is fast-forwarded to the end, it is reversed and played from the beginning of the other side.
- *In the following cases, Multi Music Scan may not operate correctly.*
 - Tapes with tunes having long pianissimo passages (very quiet parts) or non-recorded portions during tunes.
 - Tapes with short non-recorded sections.
 - Tapes with high level noise or humming between tunes.
 - The Dolby NR setting does not match. For example, if the tape is recorded with the Dolby C NR.

Other convenient tape functions

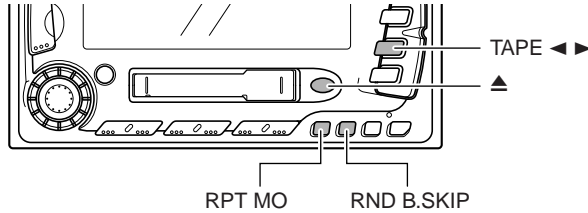

Skipping blank portions on the tape

You can skip blank portions between the tunes. (Blank Skip)



Each time you press RND B.SKIP (Random/Blank Skip) while playing a tape, the blank skip function turns on and off alternatively.

When this function is on, the B.SKIP indicator lights up on the display and the unit skips blank portions of 15 seconds or more, fast-forwards to the next tune, then starts playing it.

- When the tape reaches its end while fast-forwarding, the tape direction will be changed automatically.

Playing the current tune repeatedly

You can play the current tune repeatedly. (Repeat Play)



Each time you press RPT MO (Repeat/Monaural) while playing a tape, repeat play turns on and off alternatively. When this function is on, the RPT indicator lights up on the display.

- Repeat play will be canceled when you change the source or turn off the unit.

Prohibiting tape ejection

You can prohibit the tape ejection and can “lock” a tape in the cassette compartment.



Press and hold TAPE ◀▶ and ▲ for more than 2 seconds. “TAPE EJECT” appears, then “EJECT” flashes on the display for about 5 seconds, and the tape is “locked.”



(at the same time)

To cancel the prohibition and “unlock” the tape, press and hold TAPE ◀▶ and ▲ for more than 2 seconds again. “TAPE EJECT” appears, then “EJECT” flashes on the display for about 5 seconds, and the tape is “unlocked.”

Note:

In the following cases, Blank Skip and Repeat Play may not operate correctly.

- Tapes with tunes having long pianissimo passages (very quiet parts) or non-recorded portions during tunes.
- Tapes with short non-recorded sections.
- Tapes with high level noise or humming between tunes.
- The Dolby NR setting does not match. For example, if the tape is recorded with the Dolby C NR.

Selecting preset sound modes

You can select a preset sound adjustment suitable to the music genre.

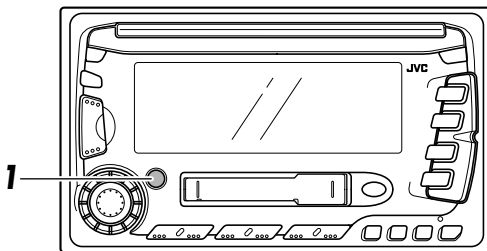

1



Select the sound mode you want.

Each time you press the button, the sound mode changes as follows.

→ SCM OFF → BEAT → SOFT → POP

Indication	For:	Preset values		
		Bass	Treble	Loudness
SCM OFF	(Flat sound)	00	00	On
BEAT	Rock or disco music	+2	00	On
SOFT	Quiet background music	+1	-3	Off
POP	Light music	+4	+1	Off

Notes:

- You can adjust the preset sound mode to your preference, and store it in memory. If you want to adjust and store your original sound mode, see “Storing your own sound adjustments” on page 21.
- To adjust the bass and treble reinforcement levels or to turn on/off the loudness function temporarily, see “Adjusting the sound” on page 20.



Adjusting the sound

You can adjust the sound characteristics to your preference.

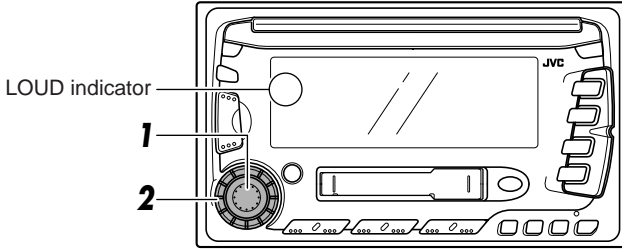

1

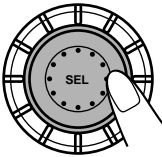

Select (“SEL”) the item you want to adjust.



Indication	To do:	Range
BAS (Bass)	Adjust the bass	-6 (min.) — +6 (max.)
TRE (Treble)	Adjust the treble	-6 (min.) — +6 (max.)
FAD (Fader)*	Adjust the front and rear speaker balance	R6 (rear only) — F6 (front only)
BAL (Balance)	Adjust the left and right speaker balance	L6 (left only) — R6 (right only)
LOUD (Loudness)	Turn on or off the loudness function**	ON — OFF
VOL (Volume)	Adjust the volume	00 (min.) — 50 (max.)

Notes:

* If you are using a two-speaker system, set the fader level to “00.”

** The loudness function can boost low and high frequencies to produce a well-balanced sound at low volume levels. When the loudness function is “ON,” the LOUD indicator changes from LOW to LOUD on the display.

2

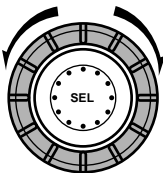

Adjust the level.

Note:

Normally the control dial works for volume adjustment. So you do not have to select “VOL” to adjust the volume level.

Storing your own sound adjustments

You can adjust the sound modes (BEAT, SOFT, POP: see page 19) to your preference and store your own adjustments in memory.

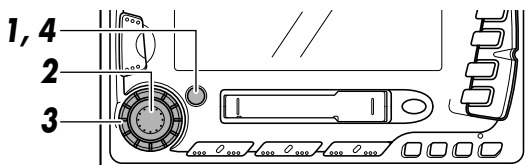
**1**

Call up the sound mode you want to adjust.
See page 19 for details.

**Within
5 seconds**

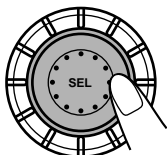
2

Select “BAS (bass),” “TRE (treble)” or “LOUD (loudness).”

**Within
5 seconds**

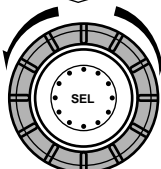
3

Adjust the selected item.
See page 20 for details.

**Within
5 seconds**

4

Press and hold SCM until “MEMO” flashes on the display.
Your setting is stored in memory.

5

Repeat the same procedure to store other settings.

To reset to the factory settings

Repeat the same procedure and reassign the preset values listed in the table on page 19.



SPECTRUM ANALYZER

ENGLISH

Selecting spectrum analyzer patterns

You can select any one from 10 different spectrum analyzer patterns or a demonstration of all the mode.

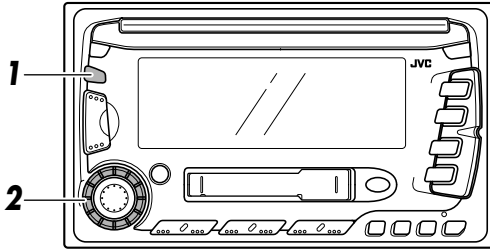

1



Select the spectrum analyzer selection mode. Each time you press the button, the spectrum analyzer selection mode turns on and off.

^{ANA} changes  to while the unit is in the spectrum analyzer selection mode.

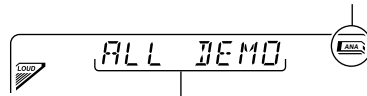

Spectrum analyzer mode currently selected

2

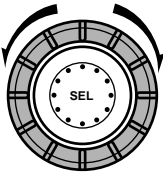

Select the spectrum analyzer selection pattern you want.

As you turn the control dial, the spectrum analyzer pattern changes as shown on the next page.



Spectrum analyser patterns

- 1. ALL DEMO** (default setting)
Demonstrate all the spectrum analyzer patterns, each for 10 seconds.

- 2. STANDARD**
Standard spectrum analyzer.



- 3. PEAK HOLD**
Hold the peak for about 2 seconds.



- 4. RAIN 1**
As if it is raining on the display.

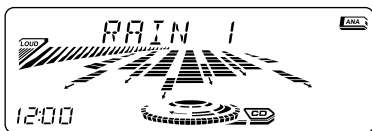

- 5. RAIN 2**
As if it is raining on the display, but from the bottom to the top.

- 6. SIDE WINDER**
Spectrum analyzer is displayed horizontally.



- 7. WAVE 1**
Wave image.



- 8. WAVE 2**
Wave image with more illumination than WAVE 1.

- 9. LEVEL 1**
Level meter with little illumination.



- 10. LEVEL 2**
Level meter with more illumination than LEVEL 1.

- 11. LEVEL 3**
Level meter with more illumination than LEVEL 2.

- 12. OFF**
No spectrum analyzer is displayed.

Changing general settings (PSM)

You can change the following settings for this unit by using the PSM (Preferred Setting Mode) control.

- PSM CLOCK (H/M): Adjusts the built-in clock (see below).
- PSM BEEP: Turns on or off the key-touch tone (see page 25).
- PSM DIMMER: Selects the dimmer mode (see page 25).
- PSM AREA: Selects the area you use this unit — when using this unit in an area other than North or South America (see page 11).
- PSM LINE IN: Selects the external component to use (see page 26).
- PSM DEMO: Turn on or off the display demonstration (see page 26).

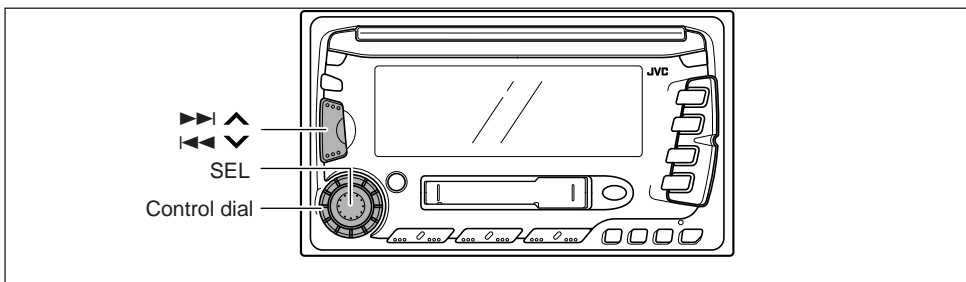

Setting the clock

After installation, set the built-in clock correctly.

1 Press SEL for more than 2 seconds.

One of the PSM items appears on the display.

2 If "PSM CLOCK H" does not appear, press **▶▶|** **▲** or **|◀◀** **▼** repeatedly until it appears.

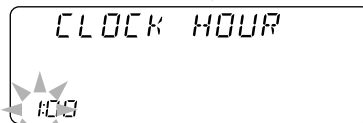
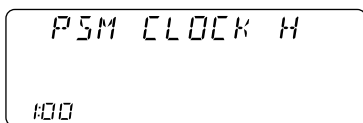

The hour digit starts flashing.

3 Turn the control dial to adjust the hour.

4 Press **▶▶|** **▲** or **|◀◀** **▼** until "PSM CLOCK M" appears on the display.

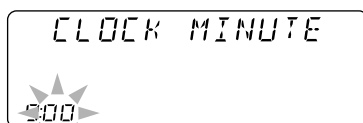
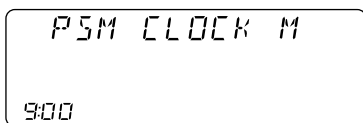

The minute digit starts flashing.

5 Turn the control dial to adjust the minute.

6 Press SEL again to finish the setting.

Turning on or off the key-touch tone

When shipped from the factory, the key-touch tone function is on so that you can hear a “beep” each time you press a button. If you want to turn off this function, follow the procedure below.

- BEEP ON: Activates the key-touch tone.
- BEEP OFF: Cancels the key-touch tone.

1 Press SEL for more than 2 seconds.

One of the PSM items appears on the display.

2 If “PSM BEEP” does not appear, press ►►| ▲ or |◄◄ ▼ repeatedly until it appears.

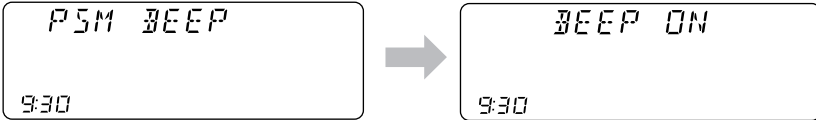

The current setting appears.

3 Turn the control dial to select the setting you want appears.

4 Press SEL again to finish the setting.

Selecting the dimmer mode

When shipped from the factory, Auto Dimmer function has been activated.

With this function in use, the display automatically dims when you turn on the car head lights.

If you want to cancel this function, follow the procedure below.

- AUTO: Activates Auto Dimmer
- ON: Activates the Dimmer.
- OFF: Cancels Auto Dimmer

1 Press SEL for more than 2 seconds.

One of the PSM items appears on the display.

2 If “PSM DIMMER” does not appear, press ►►| ▲ or |◄◄ ▼ repeatedly until it appears.

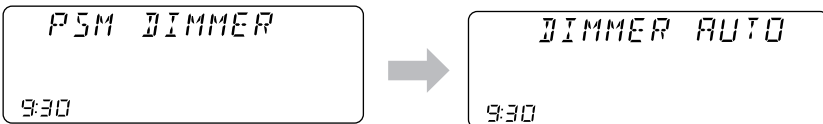

The current setting appears.

3 Turn the control dial to select the setting you want appears.

4 Press SEL again to finish the setting.

Selecting the external component to use

You can connect the external component to the CD changer jack on the rear using the Line Input Adaptor KS-U57 (not supplied).

To use the external component as the playback source through this unit, you need to select which component — CD changer or external component — to use. When shipped from the factory, CD changer is selected as the external component.

LINE IN ON: To use the external component other than CD changer

LINE IN OFF: To use the CD changer

1 Press SEL for more than 2 seconds.

One of the PSM items appears on the display.

2 If "PSM LINE IN" does not appear, press **▶▶|▲** or **|◀◀▼** repeatedly until it appears.



The current setting appears.

3 Turn the control dial to select either "LINE IN ON" (external component) or "LINE IN OFF" (CD changer).

4 Press SEL again to finish the setting.

Note:

- For connecting the Line Input Adaptor KS-U57 and the external component, refer to the Installation/Connection Manual (separate volume).

Turning on or off the display demonstration

When shipped from the factory, this function is set to on.

With this function turned on, the unit automatically starts the following display demonstration if no signal comes in for about 3 minutes except in the following case.

- When you turn on the unit for the first time after installation or after pressing the reset button, it starts if no signal comes in for about 10 seconds.

JVC ↔ CD CASSETTE

If you want to turn off the display demonstration, follow the procedure below.

1 Press SEL for more than 2 seconds.

One of the PSM items appears on the display.

2 If "PSM DEMO" does not appear, press **▶▶|▲** or **|◀◀▼** repeatedly until it appears.



The current setting appears.

3 Turn the control dial to the left to turn off the function (or turn it to the right to turn on the function again).

4 Press SEL again to finish the setting.

REMOTE OPERATIONS

Before using the remote controller:

- Aim the remote controller directly at the remote sensor on the main unit. Make sure there is no obstacle in between.
- Do not expose the remote sensor to strong light (direct sunlight or artificial lighting).

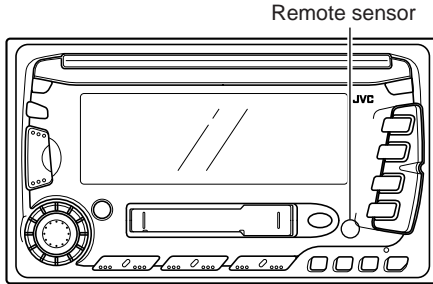

Installing the batteries

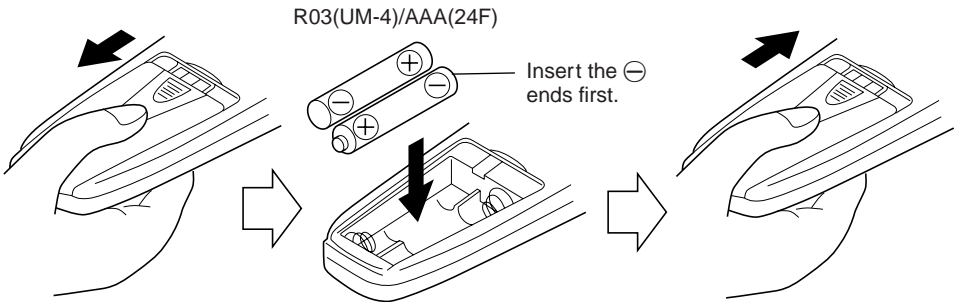

When the controllable range or effectiveness of the remote controller decreases, replace the batteries — R03(UM-4)/AAA(24F).

Using the remote controller

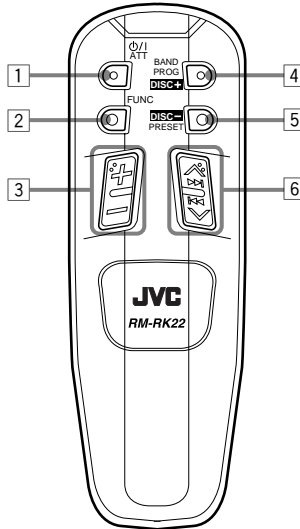

- 1 Functions the same as the ϕ/I ATT button on the main unit.
- 2 Selects the source.
Each time you press FUNC (function), the source changes.
- 3 Functions the same as the control dial on the main unit.
Note: *This button does not function for the preferred setting mode (PSM) adjustment.*
- 4
 - Changes the band while listening to the radio.
 - Changes the tape direction while listening to a tape.
 - Selects disc numbers in the increasing order, and starts playing while listening to the CD changer.
- 5
 - Selects disc numbers in the decreasing order, and starts playing while listening to the CD changer.
 - Select preset numbers in the increasing order while listening to the radio.
- 6
 - Searches stations while listening to the radio.
 - Fast forwards or reverses the track if pressed and held while listening to a CD.
 - Skips to the beginning of the next tracks or goes back to the beginning of the current (or previous tracks) if pressed briefly while listening to a CD.
 - Fast-forward or rewind a tape and find a beginning of a tune (MMS) while listening to a tape.

CD CHANGER OPERATIONS

We recommend that you use one of the CH-X series with your KW-XC770.

If you have another CD automatic changer, consult your JVC car audio dealer for connections.

- For example, if your CD automatic changer is one of the KD-MK series, you need a cord (KS-U15K) for connecting it to this unit.

Before operating your CD automatic changer:

- Refer also to the Instructions supplied with your CD changer.
- If no discs are in the magazine of the CD changer or the discs are inserted upside down, "NO DISC" will appear on the display. If this happens, remove the magazine and set the discs correctly.
- If "RESET 1 - RESET 8" appears on the display, something is wrong with the connection between this unit and the CD changer. If this happens, check the connection, connect the connecting cord(s) firmly if necessary, then press the reset button of the CD changer.

Playing CDs

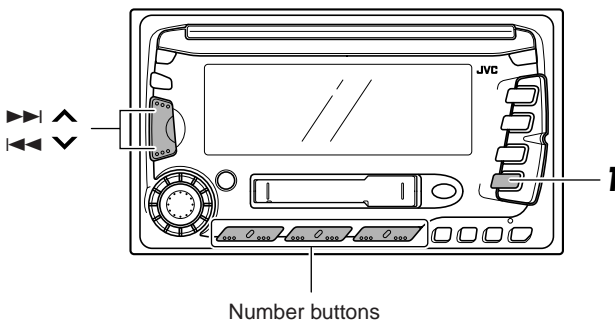

1

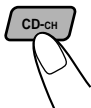

Select the CD automatic changer.

Play back starts from the first track of the first disc.
All tracks of all discs are played back.

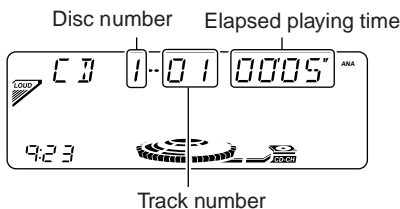

Note on One-Touch Operation:

When you press CD-CH, the power automatically comes on. You do not have to press /I ATT to turn on the power.



To fast-forward or reverse the track

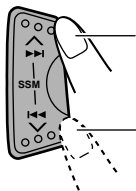

Press and hold **▶▶|▲** while playing a CD, to fast-forward the track.

Press and hold **◀◀|▼** while playing a CD, to reverse the track.

To go to the next tracks or the previous tracks

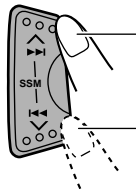

Press **▶▶|▲** briefly while playing a CD, to go ahead to the beginning of the next track. Each time you press the button consecutively, the beginning of the next tracks is located and played back.

Press **◀◀|▼** briefly while playing a CD, to go back to the beginning of the current track. Each time you press the button consecutively, the beginning of the previous tracks is located and played back.

To go to a particular disc directly

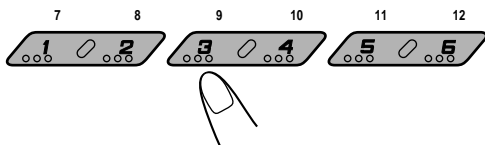

Press the number button corresponding to the disc number to start its playback (while CD changer is playing).

- To select a disc number from 1 – 6:
Press 1 (7) – 6 (12) briefly.
- To select a disc number from 7 – 12:
Press and hold 1 (7) – 6 (12) for more than 1 second.

Ex. When disc number 3 is selected.

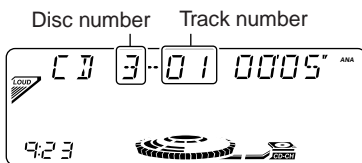



Selecting CD playback modes

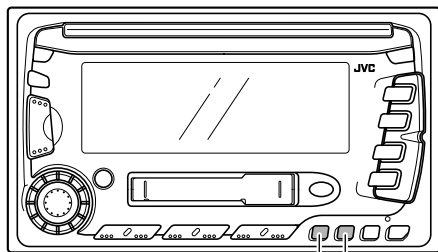

RPT MO RND B.SKIP

To play back tracks at random (Random Play)



Each time you press RND B.SKIP (Random/Blank Skip) while playing a CD, CD random play mode changes as follows:



Mode	RND indicator	Plays at random
RANDOM 1 ON	Lights	All tracks of the current disc, then the tracks of the next disc, and so on.
RANDOM 2 ON	Flashes	All tracks of all discs inserted in the magazine.
RANDOM OFF	Goes off	Canceled.

To play back tracks repeatedly (Repeat Play)

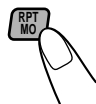

Each time you press RPT MO (Repeat/Monaural) while playing a CD, CD repeat play mode changes as follows:



Mode	RPT indicator	Plays repeatedly
REPEAT 1 ON	Lights	The current track (or specified track).
REPEAT 2 ON	Flashes	All tracks of the current disc (or specified disc).
REPEAT OFF	Goes off	Canceled.



EXTERNAL COMPONENT OPERATIONS

ENGLISH

You can connect the external component to the CD changer jack on the rear using the Line Input Adaptor KS-U57 (not supplied).

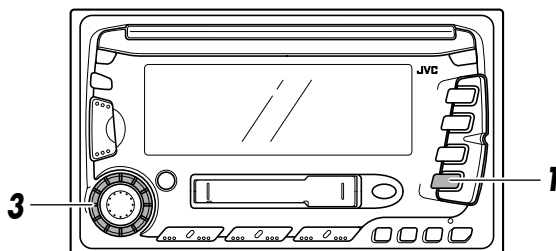

Preparations:

- For connecting the Line Input Adaptor KS-U57 and the external component, refer to the Installation/Connection Manual (separate volume).
- Before operating the external component using the following procedure, select the external input correctly. (See “Selecting the external component to use” on page 26.)

1



Select the external component.

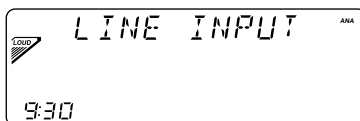

- If “LINE INPUT” does not appear on the display, see page 26 and select the external input (“PSM LINE IN”).

Note on One-Touch Operation:

When you press CD-CH, the power automatically comes on. You do not have to press ATT to turn on the power.

2

Turn on the connected component and start playing the source.

3

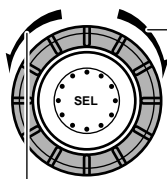

To turn up the volume

Adjust the volume.

To turn down the volume

Handling cassettes

The cassette deck built in this unit requires very little attention, but you will be able to extend the life of the cassette deck if you follow the instructions below.

To clean the heads

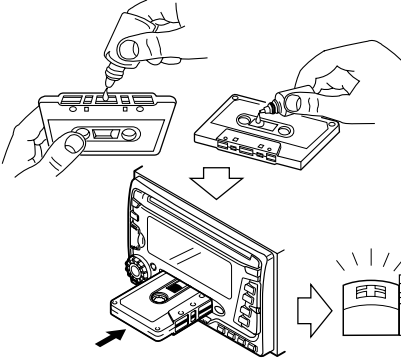

- Clean the heads after every 10 hours of use using a wet-type head cleaning tape (available at an audio store).
When the head becomes dirty, you may realize the following symptoms:
 - Sound quality is reduced.
 - Sound level decreases.
 - Sound drops out.
- Do not play dirty or dusty tapes.
- Do not touch the highly-polished head with any metallic or magnetic tools.

To keep the tape clean

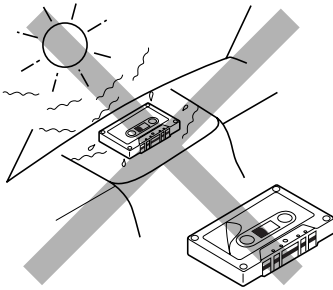

- Always store the tapes to their storage cases after use.
- Do not store tapes in the following places:
 - Subject to direct sunlight
 - With high humidity
 - At extremely hot temperatures

CAUTIONS:

- Do not play the tapes with peeling labels; otherwise, they can damage the unit.
- Tighten tapes to remove slack since loose tape may become entangled with the mechanism.
- Do not leave a cassette in the cassette compartment after use, as the tape may become slack.

The function below is also provided to ensure the longer life of the cassette deck.

Ignition key-off release

- When you turn off the ignition key with a cassette in the compartment, the unit automatically releases the tape from its head.



Handling CDs

The CD player built in this unit has been designed only to play back the CDs bearing the  mark. Other discs cannot be played back.

How to handle CDs

When removing a CD from its case, press down the center holder of the case and lift the CD out, holding it by the edges.

- Always hold the CD by the edges. Do not touch its recording surface.
- When storing a CD into its case, gently insert the CD around the center holder (with the printed surface facing up).
- Make sure to store CDs into the cases after use.

Center holder



To keep CDs clean

A dirty CD may not play correctly. If a CD does become dirty, wipe it with a soft cloth in a straight line from center to edge.



To play new CDs

New CDs may have some rough spots around the inner and outer edges. If such a CD is used, this unit may reject the CD.

To remove these rough spots, rub the edges with a pencil or ball-point pen, etc.

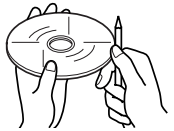

Moisture condensation

Moisture may condense on the lens inside the CD player in the following cases:

- After starting the heater in the car.
- If it becomes very humid inside the car.

Should this occur, the CD player may malfunction. In this case, eject the CD and leave the unit turned on for a few hours until the moisture evaporates.

CAUTIONS:

- Do not insert 8 cm (3 3/16") CDs (single CDs) into the loading slot. (Such CDs cannot be ejected.)
- Do not insert any CD of unusual shape — like a heart or flower; otherwise, it will malfunction.
- Do not expose CDs to direct sunlight or any heat source or place them in a place subject to high temperature and humidity. Do not leave them in a car.
- Do not use any solvent (for example, conventional record cleaner, spray, thinner, benzine, etc.) to clean CDs.

When playing a CD-R (Recordable)

You can play back your original CD-Rs on this unit.

- Before playing back CD-Rs, read their instructions or cautions carefully.
- Some CD-Rs recorded on CD recorders may not be played back on this unit because of their disc characteristics, and of the following reasons:
 - Discs are dirty or scratched.
 - Moisture condensation occurs on the lens inside the unit.
 - The pickup lens inside the unit is dirty.
- Use only “finalized” CD-Rs.
- CD-RWs (Rewritable) cannot be played back on this unit.
- Do not use the CD-Rs with stickers or sticking labels on the surface. They may cause malfunctions.

TROUBLESHOOTING

What appears to be trouble is not always serious. Check the following points before calling a service center.

Symptoms	Causes	Remedies
• CD cannot be played back.	CD is inserted upside down.	Insert the CD correctly.
• CD sound is sometimes interrupted.	You are driving on rough roads.	Stop CD play while driving on rough roads.
	CD is scratched.	Change the CD.
	Connections are incorrect.	Check the cords and connections.
• “NO DISC” appears on the display.	No CD is in the loading slot. (or in the magazine).	Insert CD.
	CD is inserted incorrectly.	Insert it correctly.
• A cassette tape cannot be inserted.	You have tried to insert a cassette in the wrong way.	Insert the cassette with the exposed tape facing right.
• Cassette tapes become hot.	This is not a malfunction.	—————
• Tape sound is at very low level and sound quality is degraded.	The tape head is dirty.	Clean it with a head cleaning tape.
• Sound is sometimes interrupted.	Connections are not good.	Check the cords and connections.
• Sound cannot be heard from the speakers.	The volume control is turned to the minimum level.	Adjust it to the optimum level.
	Connections are incorrect.	Check the cords and connections.
• SSM automatic preset does not work.	Signals are too weak.	Store stations manually.
• Static noise while listening to the radio.	The antenna is not connected firmly.	Connect the antenna firmly.
• “NO MAGAZINE” appears on the display.	No magazine is in the CD changer.	Insert the magazine.

CONTINUED TO THE NEXT PAGE



Symptoms	Causes	Remedies
<ul style="list-style-type: none">• “RESET 8” appears on the display.	This unit is not connected to a CD changer correctly.	Connect this unit and the CD changer correctly and press the reset button of the CD changer.
<ul style="list-style-type: none">• “RESET 1-RESET 7” appears on the display.	_____	Press the reset button of the CD changer.
<ul style="list-style-type: none">• CD can neither be played back nor ejected.	The CD player may function incorrectly.	While holding ▲ for the CD player, press DIS/ATT for more than 2 seconds. Be careful not to drop CD when it is ejected.
<ul style="list-style-type: none">• This unit does not work at all.• The CD changer does not work at all.	The built-in microcomputer may function incorrectly due to noise, etc.	Press the reset button on the front panel (See page 2.)

About mistracking:

Mistracking may result from driving on extremely rough roads. This does not damage the unit and the CD, but will be annoying. We recommend that you stop CD play while driving on such rough roads.

SPECIFICATIONS

AUDIO AMPLIFIER SECTION

Maximum Power Output:

Front: 40 W per channel

Rear: 40 W per channel

Continuous Power Output (RMS):

Front: 16 W per channel into 4 Ω ,
40 Hz to 20,000 Hz at no more
than 0.8% total harmonic
distortion.

Rear: 16 W per channel into 4 Ω ,
40 Hz to 20,000 Hz at no more
than 0.8% total harmonic
distortion.

Load Impedance: 4 Ω (4 to 8 Ω allowance)

Tone Control Range:

Bass: ± 10 dB at 100 Hz

Treble: ± 10 dB at 10 kHz

Frequency Response: 40 Hz to 20,000 Hz

Signal-to-Noise Ratio: 70 dB

Line-Out Level/Impedance:

2.0 V/20 k Ω load (full scale)

Output Impedance: 1 k Ω

TUNER SECTION

Frequency Range:

FM: 87.5 MHz to 107.9 MHz

(with channel interval set to 200 kHz)

87.5 MHz to 108.0 MHz

(with channel interval set to 50 kHz)

AM: 530 kHz to 1,710 kHz

(with channel interval set to 10 kHz)

531 kHz to 1,602 kHz

(with channel interval set to 9 kHz)

[FM Tuner]

Usable Sensitivity: 11.3 dBf (1.0 μ V/75 Ω)

50 dB Quieting Sensitivity:

16.3 dBf (1.8 μ V/75 Ω)

Alternate Channel Selectivity (400 kHz):

65 dB

Frequency Response: 40 Hz to 15,000 Hz

Stereo Separation: 30 dB

Capture Ratio: 1.5 dB

[AM Tuner]

Sensitivity: 20 μ V

Selectivity: 35 dB

CD PLAYER SECTION

Type: Compact disc player

Signal Detection System: Non-contact optical
pickup (semiconductor laser)

Number of channels: 2 channels (stereo)

Frequency Response: 5 Hz to 20,000 Hz

Dynamic Range: 96 dB

Signal-to-Noise Ratio: 98 dB

Wow and Flutter: Less than measurable limit

CASSETTE DECK SECTION

Wow and Flutter: 0.11% (WRMS)

Fast-Wind Time: 100 sec. (C-60)

Frequency Response: 50 Hz to 16,000 Hz

Signal-to-Noise Ratio:

Dolby B NR ON: 64 dB

Dolby B NR OFF: 56 dB

Stereo Separation: 40 dB

GENERAL

Power Requirement:

Operating Voltage: DC 14.4 V (11 V to 16
V allowance)

Grounding System: Negative ground

Allowable Working Temperature:

0°C to +40°C (32°F to 104°F)

Dimensions (W x H x D):

Installation Size:

178 mm x 100 mm x 150 mm

(7-1/16" x 3-15/16" x 5-15/16")

Front Panel Size:

170 mm x 92 mm x 15 mm

(6-3/4" x 3-5/8" x 5/8")

Mass: 2.2 kg (4.9 lbs) (excluding accessories)

*Design and specifications subject to change
without notice.*

If a kit is necessary for your car, consult
your telephone directory for the nearest
car audio speciality shop.



**Having TROUBLE with operation?
Please reset your unit**

**Refer to page of How to Reset
Still having trouble??**

USA ONLY

Call 1-800-252-5722

<http://www.jvcservice.com>

We can help you!

JVC

VICTOR COMPANY OF JAPAN, LIMITED